



BAV99

DIODE

HIGH CONDUCTANCE ULTRA FAST DIODE

■ EQUIVALENT

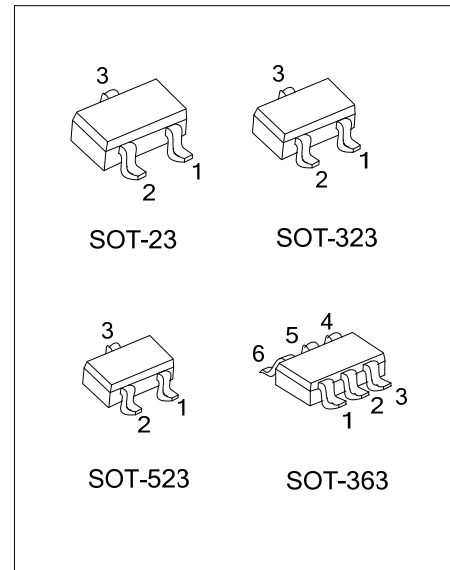
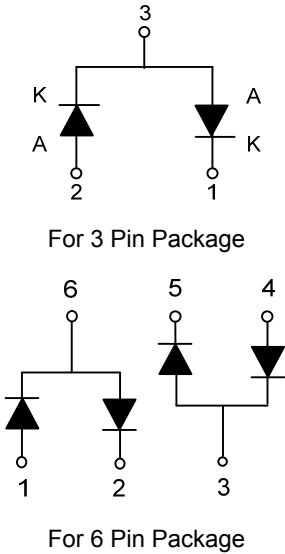

■ ORDERING INFORMATION

Ordering Number		Package	Pin Assignment						Packing
Lead Free	Halogen Free		1	2	3	4	5	6	
BAV99L-AE3-R	BAV99G-AE3-R	SOT-23	K1	A2	K2A1	-	-	-	Tape Reel
BAV99L-AL3-R	BAV99G-AL3-R	SOT-323	K1	A2	K2A1	-	-	-	Tape Reel
BAV99L-AN3-R	BAV99G-AN3-R	SOT-523	K1	A2	K2A1	-	-	-	Tape Reel
BAV99L-AL6-R	BAV99G-AL6-R	SOT-363	A1	K1	A2K2	A2	K2	A1K1	Tape Reel

Note: Pin Assignment: A: Anode K: Cathode

<p>BAV99L-AE3-R</p> <p>(1)Packing Type (2)Package Type (3)Lead Plating</p>	<p>(1) R: Tape Reel (2) AE3: SOT-23, AL3: SOT-523, AN3: SOT-523, AL6: SOT-363 (3) G: Halogen Free, L: Lead Free</p>
--	---

■ MARKING

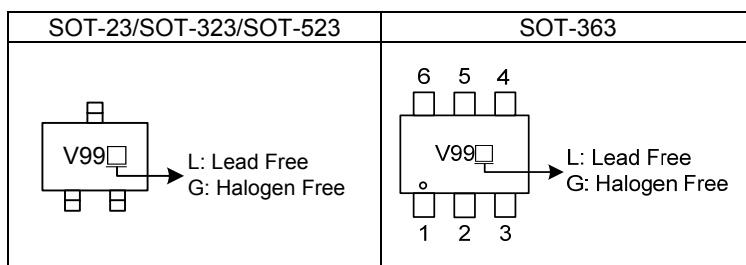

■ ABSOLUTE MAXIMUM RATINGS* (Ta = 25°C, unless otherwise specified.)

PARAMETER		SYMBOL	RATINGS	UNIT
Working Inverse Voltage		V_{IV}	70	V
Average Rectified Current		$I_{F(AV)}$	200	mA
DC Forward Current		I_{FM}	600	mA
Recurrent Peak Forward Current		I_{FRM}	700	mA
Non-repetitive Peak Forward Surge Current	Pulse width = 1.0 second	I_{FSM}	1.0	A
	Pulse width = 1.0 microsecond		2.0	A
Power Dissipation	SOT-23	P_D	350	mW
	SOT-523		150	mW
	SOT-323/SOT-363		200	mW
Junction Temperature		T_J	+150	°C
Storage Temperature		T_{STG}	-65 ~ +150	°C

Note: 1. Absolute maximum ratings are those values beyond which the device could be permanently damaged.

Absolute maximum ratings are stress ratings only and functional device operation is not implied.

2. These are steady state limits. The factory should be consulted on applications involving pulsed or low duty cycle operations.

■ THERMAL DATA

PARAMETER		SYMBOL	RATINGS	UNIT
Junction to Ambient	SOT-23	θ_{JA}	357	°C /W
	SOT-523		833	°C /W
	SOT-323/SOT-363		625	°C /W

■ ELECTRICAL CHARACTERISTICS (Ta = 25°C, unless otherwise specified.)

PARAMETER	SYMBOL	TEST CONDITIONS	MIN	TYP	MAX	UNIT
Breakdown Voltage	V_R	$I_R = 100\mu A$	70			V
Maximum Instantaneous Forward Voltage	V_{FM}	$I_F = 1.0mA$			775	mV
		$I_F = 10mA$			855	mV
		$I_F = 50mA$			1.0	V
		$I_F = 150mA$			1.25	V
Peak Forward Voltage	V_{SM}	$I_F = 10mA, t_R = 20nS$			1.75	V
Maximum Instantaneous Reverse Current	I_{RM}	$V_R = 70V$			2.5	μA
		$V_R = 25V, T_a = 150^\circ C$			30	
		$V_R = 70V, T_a = 150^\circ C$			50	
Diode Capacitance	C_O	$V_R = 0, f = 1.0MHz$			1.5	pF
Reverse Recovery Time	t_{RR}	$I_F = I_R = 10mA, I_{RR} = 1.0mA$ $R_L = 100\Omega$			6.0	ns

TYPICAL CHARACTERISTICS

Reverse Voltage vs. Reverse Current
BV - 1.0 ~ 100 μ A

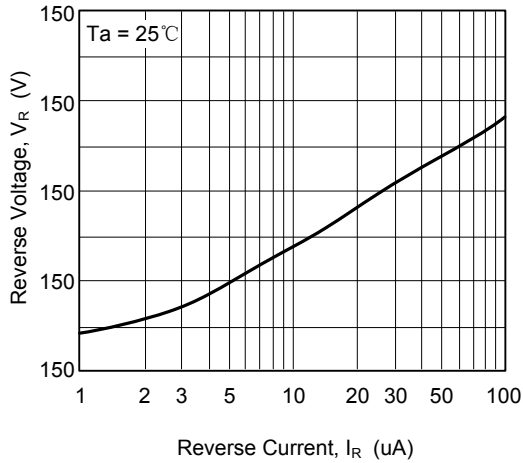

Reverse Current vs. Reverse Voltage
 I_R - 10 ~ 100 V

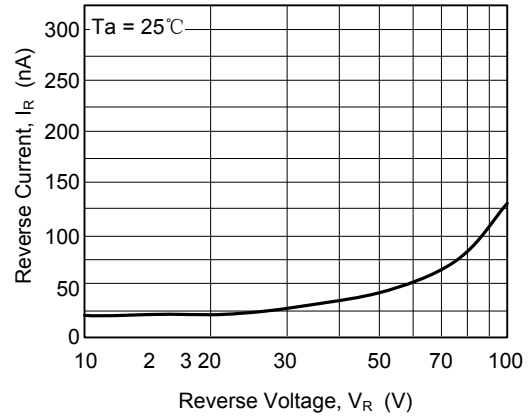

GENERAL RULE: The Reverse Current of a diode will approximately double for every ten (10) Degree C increase in Temperature

Forward Voltage vs. Forward Current
 V_F - 1.0 ~ 100 μ A

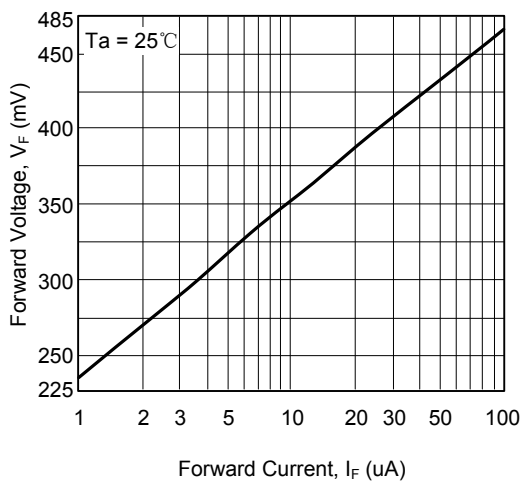

Forward Voltage vs. Forward Current
 V_F - 0.1 ~ 10 mA

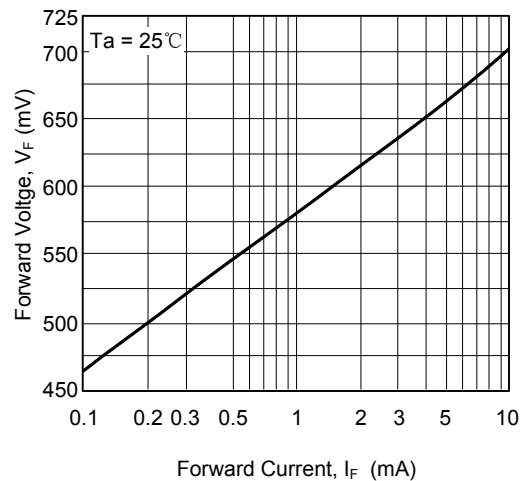

Forward Voltage vs. Forward Current
 V_F - 1.0 ~ 800 mA

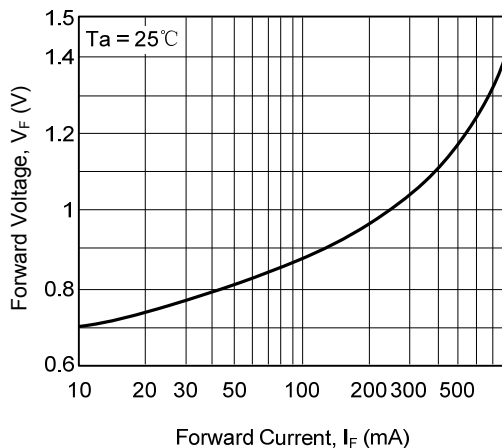

Capacitance vs. Reverse Voltage
 V_R - 0.0 ~ 15 V

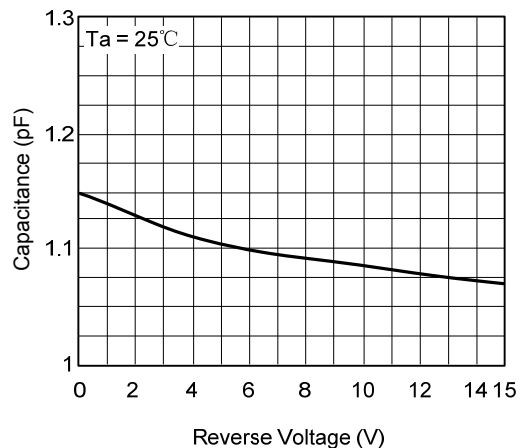

■ TYPICAL CHARACTERISTICS(Cont.)

Reverse Recovery Time vs. Reverse Current TRR - IR 10 mA vs. 60 mA

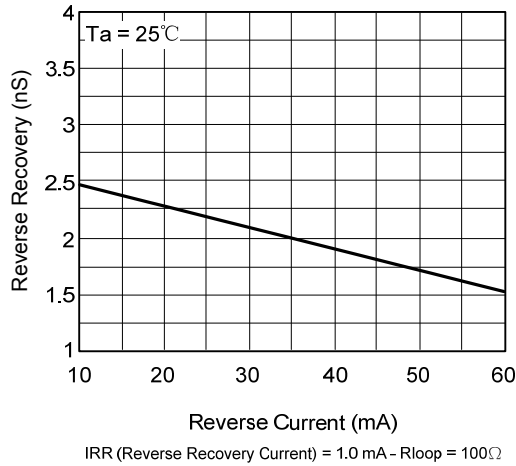

Average Rectified Current (Io) & Forward Current (If) versus Ambient Temperature (Ta)

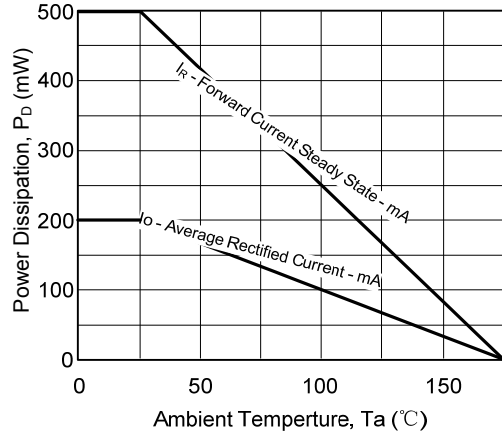

Power Derating Curve

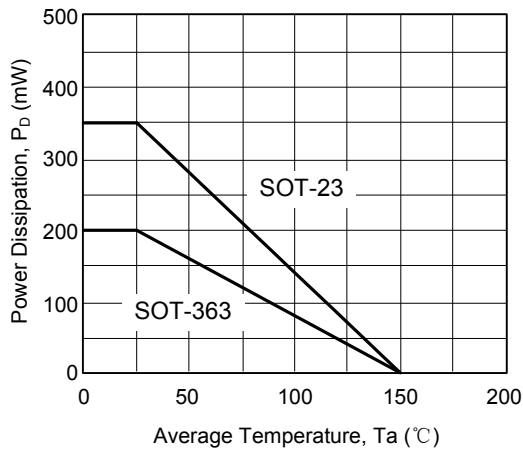

UTC assumes no responsibility for equipment failures that result from using products at values that exceed, even momentarily, rated values (such as maximum ratings, operating condition ranges, or other parameters) listed in products specifications of any and all UTC products described or contained herein. UTC products are not designed for use in life support appliances, devices or systems where malfunction of these products can be reasonably expected to result in personal injury. Reproduction in whole or in part is prohibited without the prior written consent of the copyright owner. The information presented in this document does not form part of any quotation or contract, is believed to be accurate and reliable and may be changed without notice.